



---

# INVISA COOK



# INSTALLATION MANUAL

# DESCRIPTION

**Thank you for your purchase of InvisaCook! Now let's get ready to install it.**

There are many options, layouts and ways to install InvisaCook into your kitchen design, but we have 3 basic options for you, depending on the burner unit purchased.

Please follow these directions and options for best results of your install and/or design.

## **Index:**

Pages 3-4: Dimensions of your Unit

Pages 5-6: Sink Clip and Rail Option Layout

Page 7: Installation of Sink Clips and How to

Page 8: Power Plugs, Power Cables, and Controller Cable Info

Page 9: Hardwire Diagram and Directions

Pages 10-11: Controller Install - Drawer in Drawer or Bottom of Drawer

Pages 12-15: Controller Install – Controller Countertop Install

Page 16: Controller Install – Cabinet Face Frame Controller Install

Page 17: Installation of Wall Oven Underneath the InvisaCook

Page 18: Controller Drawing & Layout

Pages 19-21: Controller Functionality

Pages 22-23: Unit Power Consumption and Info

Installation YouTube Video: <https://www.youtube.com/watch?v=she5eRPK1FE>

**Note:** Directions provided by InvisaCook on installation of your unit are general instructions. If your Countertop Brand Manufacturer has other directions with regards to the installation, those must be followed to maintain the stone's warranty.

# STEP #1 Know what unit you are installing and its size in MM.

1 Burner 110V

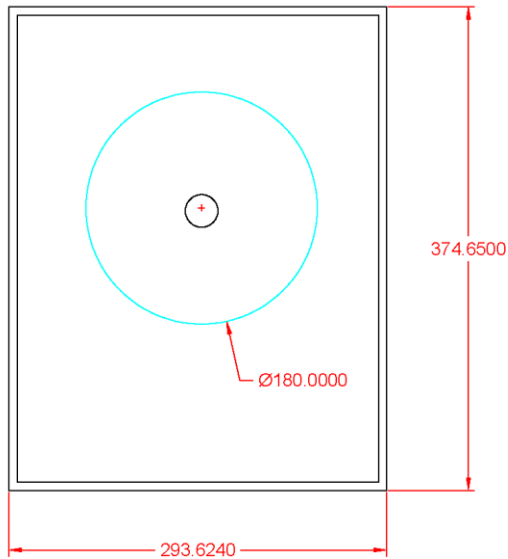

2 Burner 110V & 220V

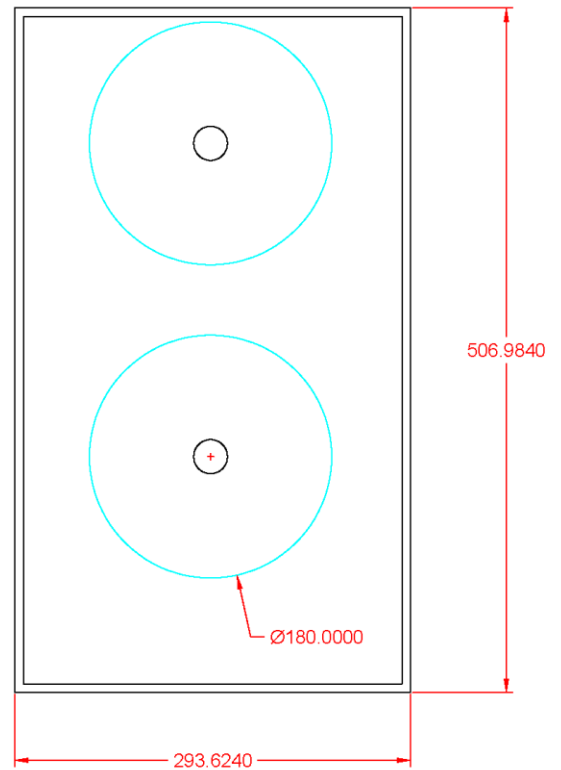

4 Burner 220V

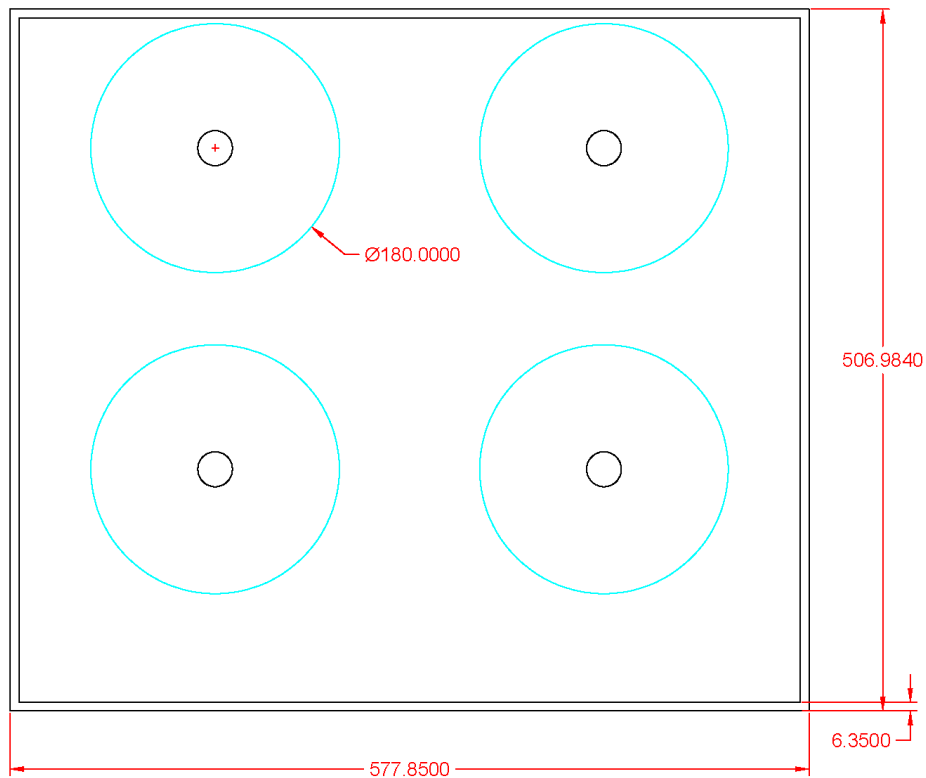

### 3 Burner 220V

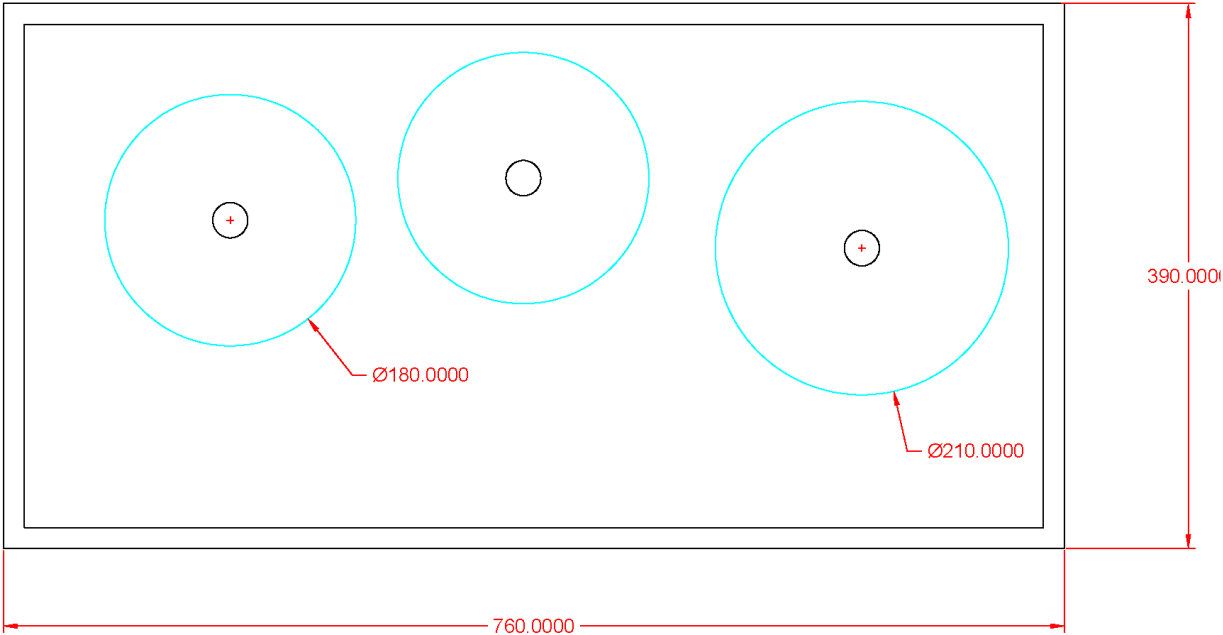

### 5 Burner 220V

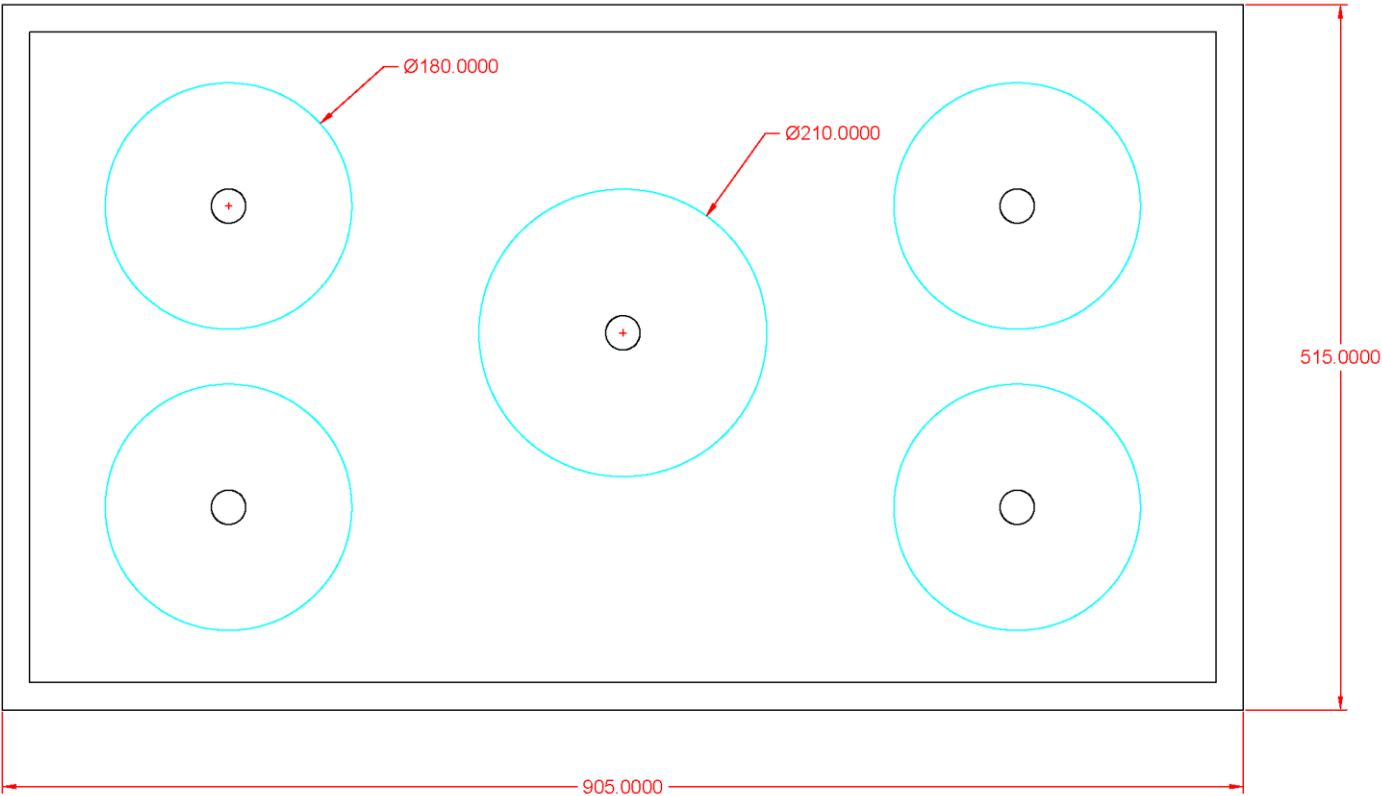

**Step #2** If you are going to Install using sink Clips, here is the orientation of how the sink Clips  should be installed. If using Rail System, same edges apply to hold the unit up properly to the bottom of the surface.

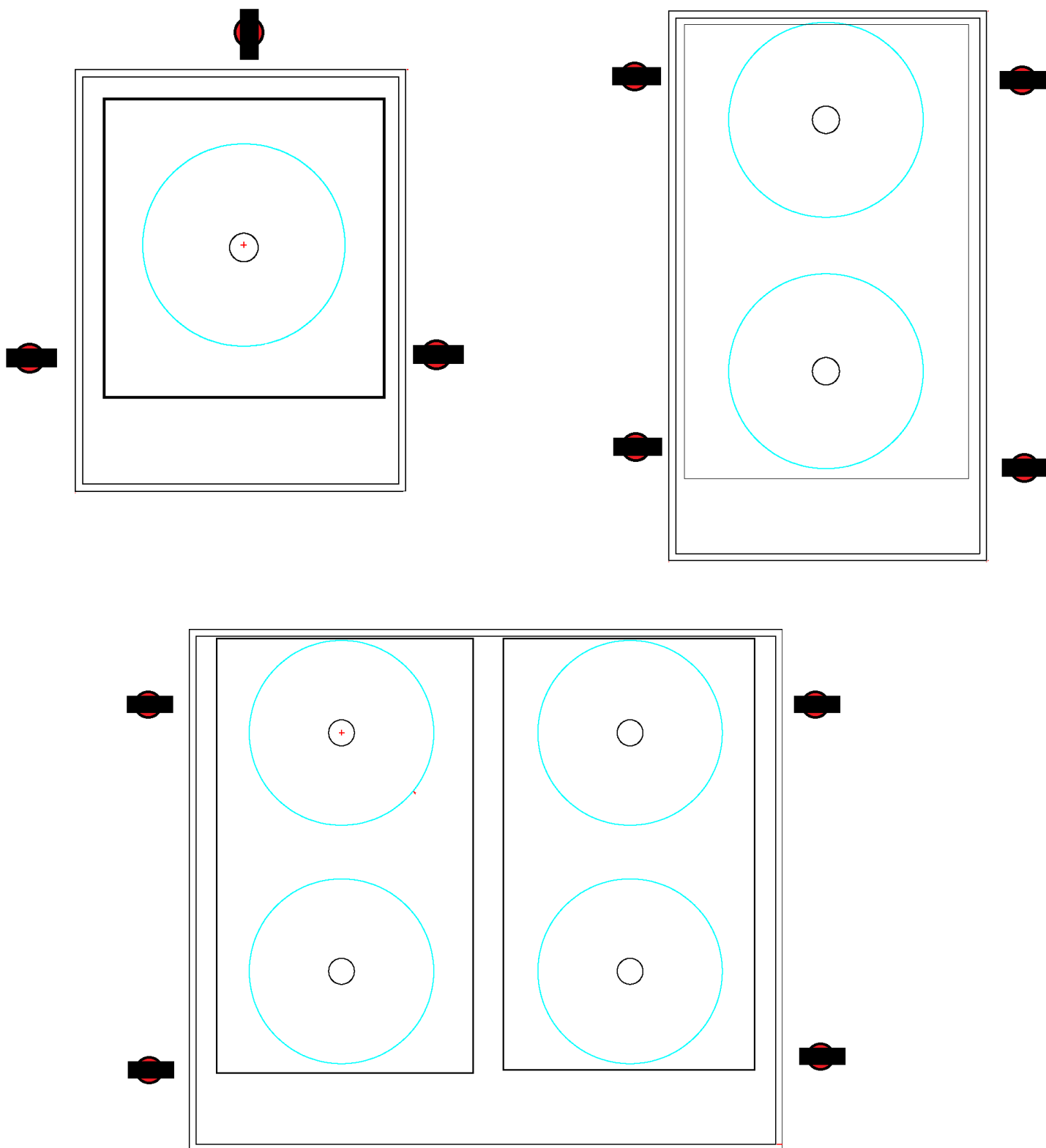

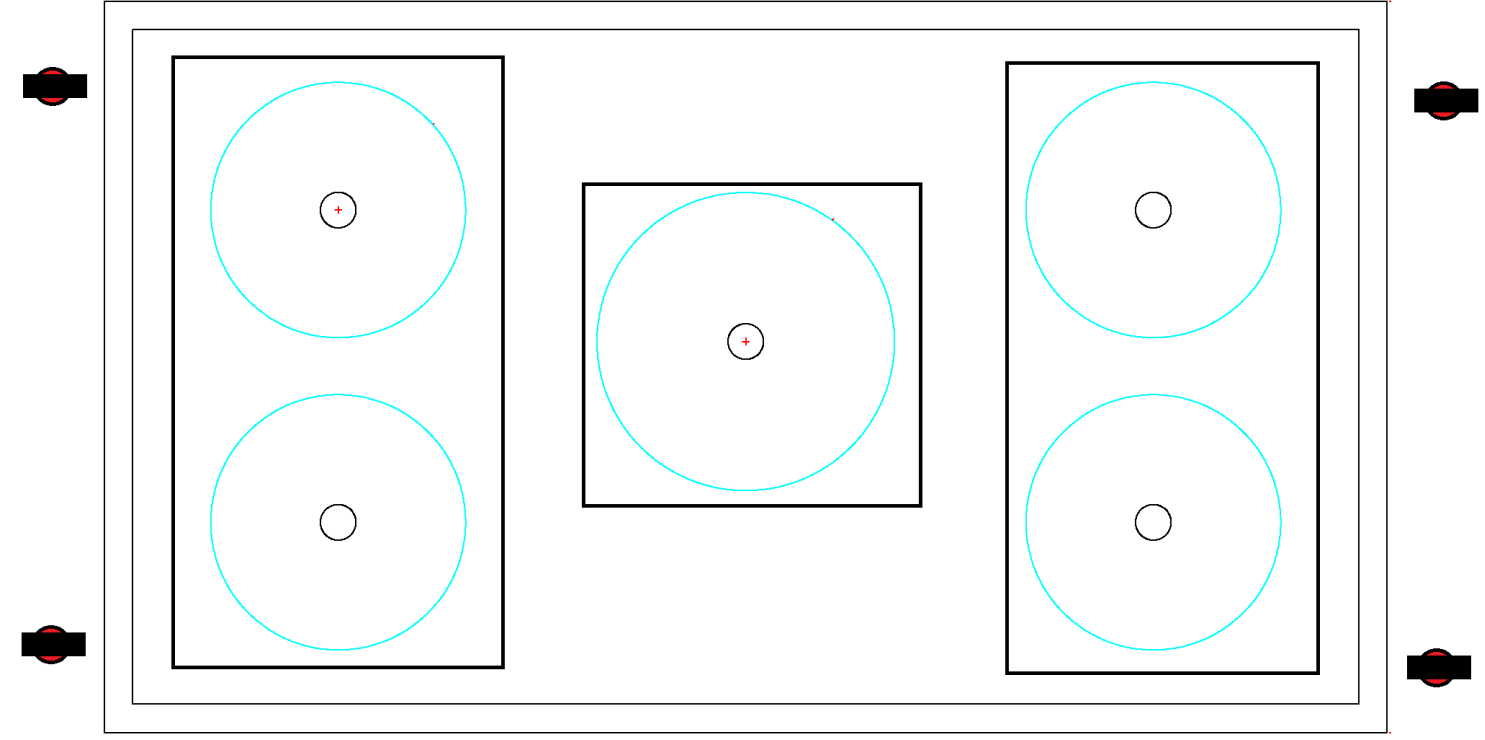
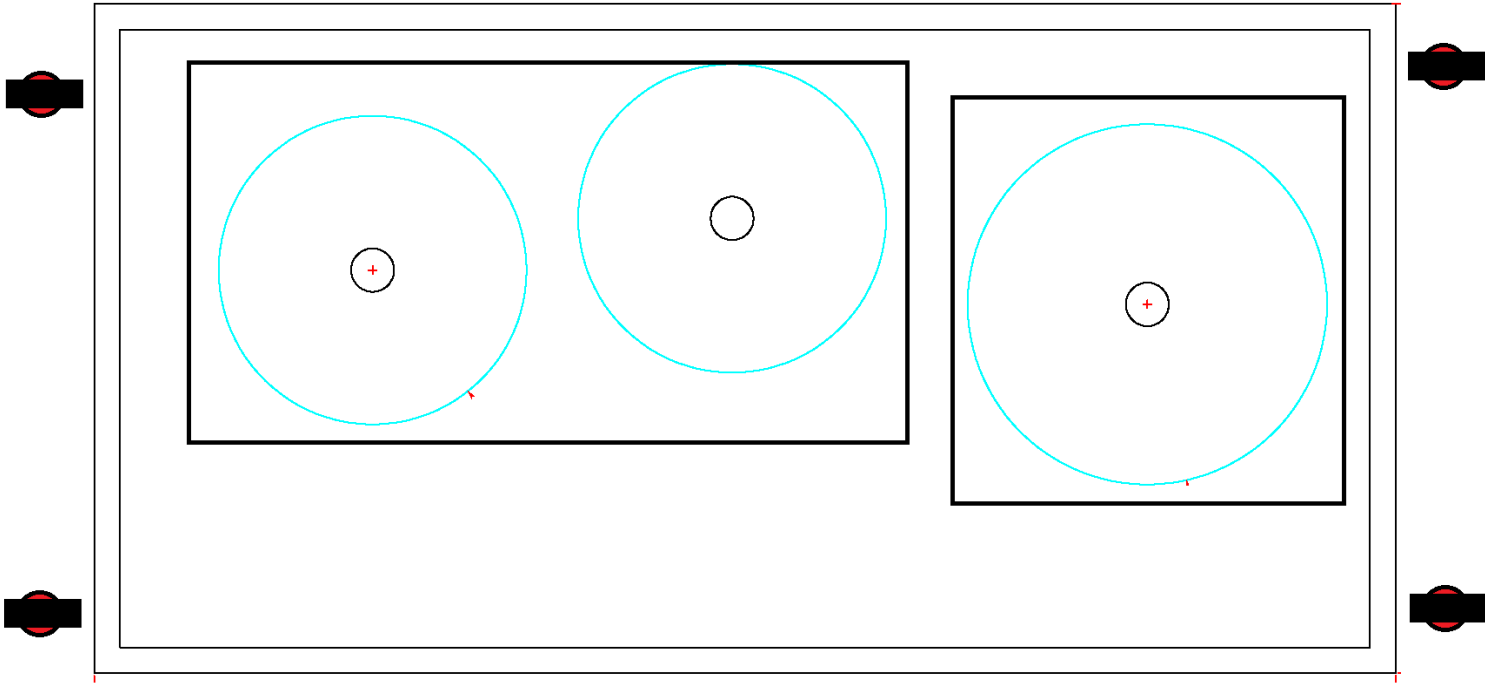

# Installation With Sink Clips or Rail Notes:

When installing the Sink Clips, you can use a Seam Glue to Adhere the Sink Clips to the Countertop Surface, or a 2-part High Head JB-Weld, which might need 24 hours to cure before installation.

- 12mm Porcelain with a back Meshing is preferred for the sink clip method, but not required.

*NOTE: Meshing does not need to be removed in the area of the cooktop*

- See pictures below of properly adhered Sink Clips



- From this point, slide the unit into place, before fastening down the clip so it is secured.
- There should be no wiggle room at this point to the unit. Once securely fastened and tightened causes the the magneto nub on top of each burner to activate along with the temperature sensor for proper use.

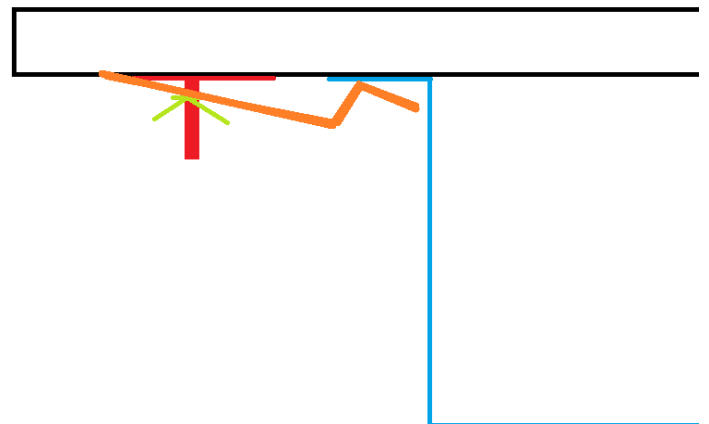

# Plugs and Power Cables Info

All Power Cables are 140cm long in length and can be Hardwired, if taken off the plug or if country mandated or required.

North America Units come with a Plug that is a Twistlock Plug.  
30 Amp, 250 Volt, 2 Pole 3 Wire Grounding

- Solid Brass Blades & Receptacles
- Reinforced Ground Pins & Blades
- Hand Machined & Milled Parts
- Color Coded Wire Inserts



# Controller Cables Info

Controller Cables are made of UL2468 8 core AWM 2468 26AWG VW-1 80C 300V PVC Insulated Wire, with a male end of the cord to connect to the female end on the outside of controller box. All controller cables are 1.5 meters long (5500 cm)

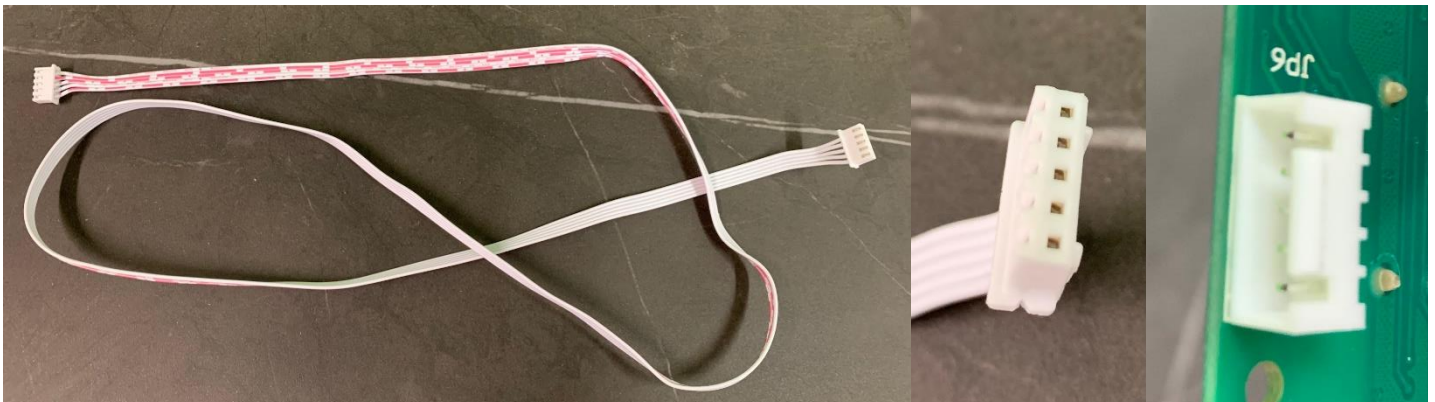



# Hardwire Diagram and Info

## 3 & 4 Burner Option

Invisacook 4 Burner:  
220-240V ac 50-60Hz  
7,2 kW total shared  
recommended minimum cable supply: 3G 6mm

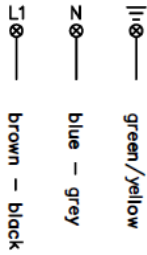

Invisacook 4 Burner:  
3 x 220-240V ac 50-60Hz  
7,2 kW total shared  
recommended minimum cable supply: 5G 4mm

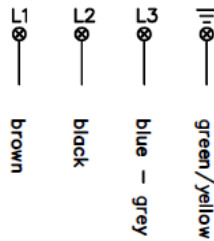

Invisacook 4 Burner:  
3 x 380-415V ac 50-60Hz  
7,2 kW total shared  
recommended minimum cable supply: 5G 4mm

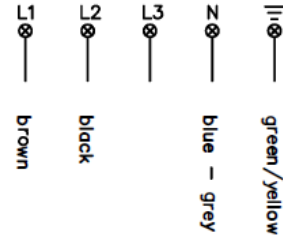

## 5 Burner Option

Invisacook 5 Burner:  
220-240V ac 50-60Hz  
10,2 kW total shared  
recommended minimum cable supply: 3G 10mm'

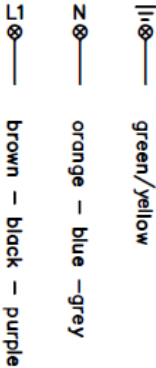

Invisacook 5 Burner:  
3 x 220-240V ac 50-60Hz  
10,2 kW total shared  
recommended minimum cable supply: 5G 6mm'

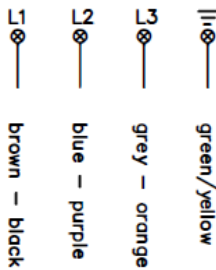

Invisacook 5 Burner:  
3 x 380-415V ac 50-60Hz  
10,2 kW total shared  
recommended minimum cable supply: 5G 4mm'

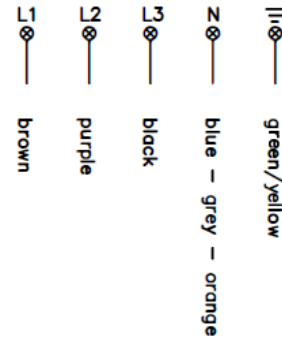

## 2 Burner Option

Invisacook 2 Burner:  
220-240V ac 50-60Hz  
3,6 kW total shared  
recommended minimum cable supply: 3G 2,5mm'

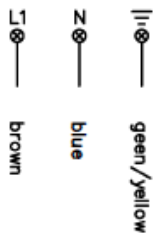

### HARDWIRE WIRE COMBINATION

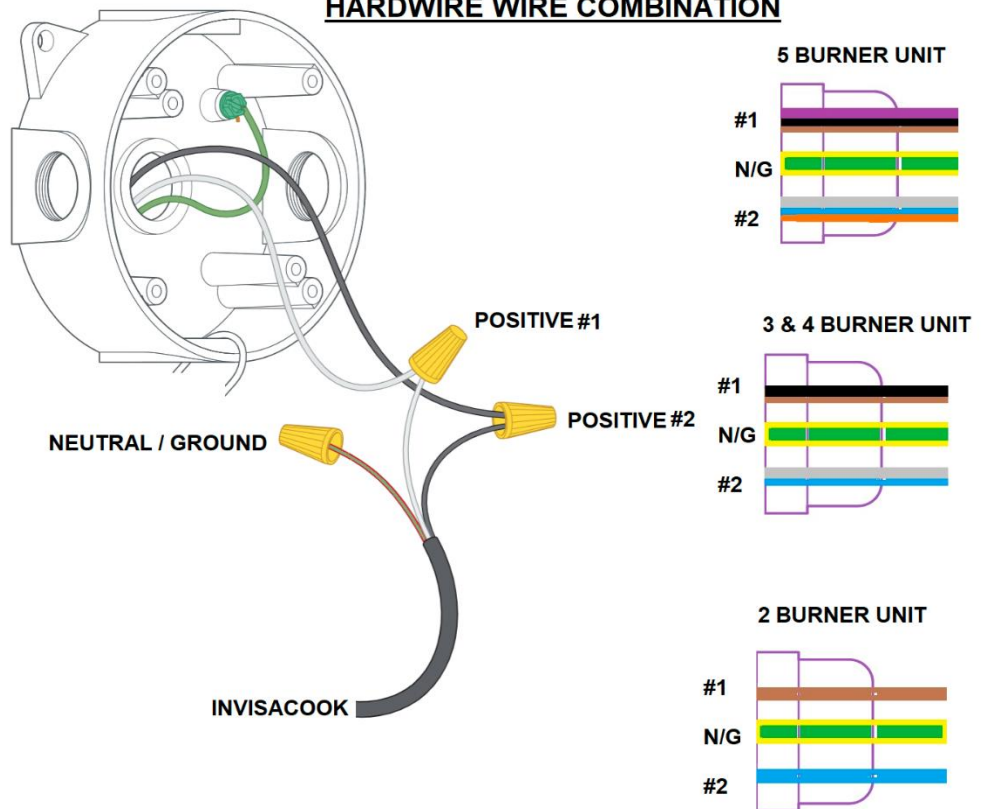

# Drawer Slide Out Controller Option

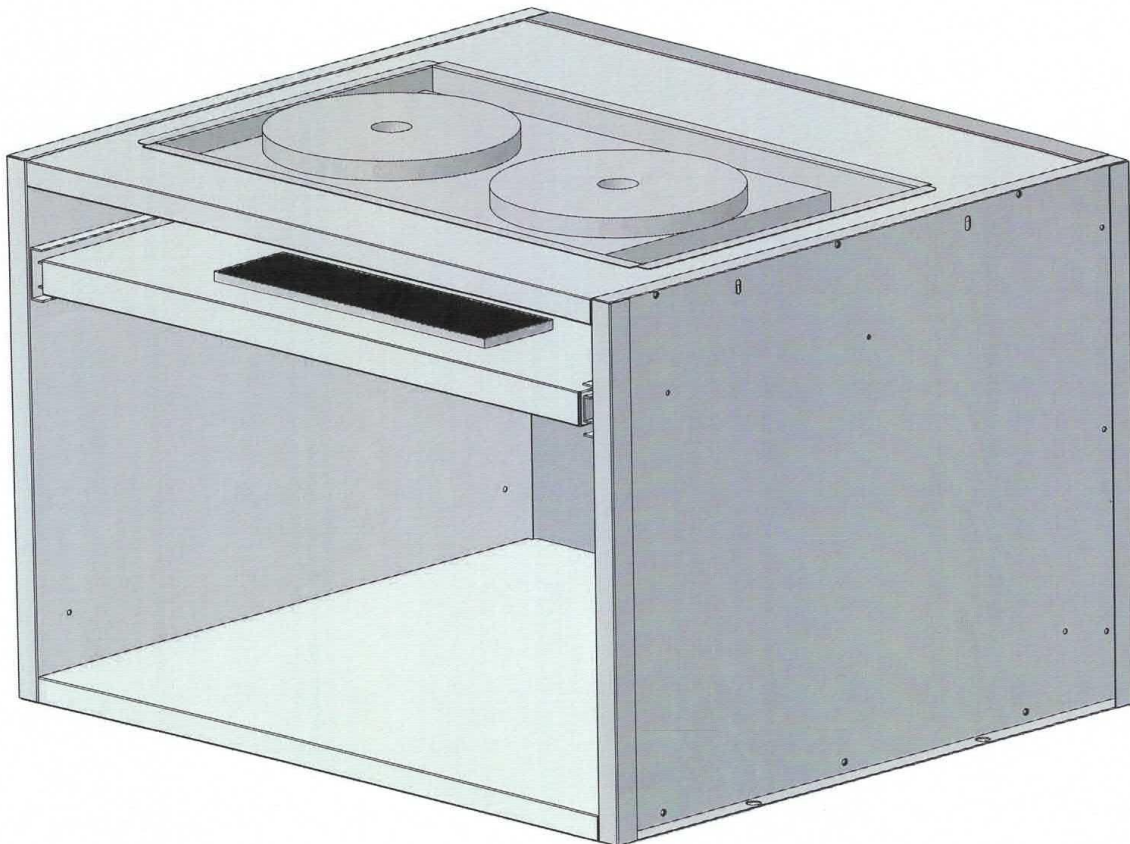

Drawer Size option depending on Cabinet width, with hole cutout size to drop in Controller in 15cm drawer or bottom of existing drawer

91.5 CM

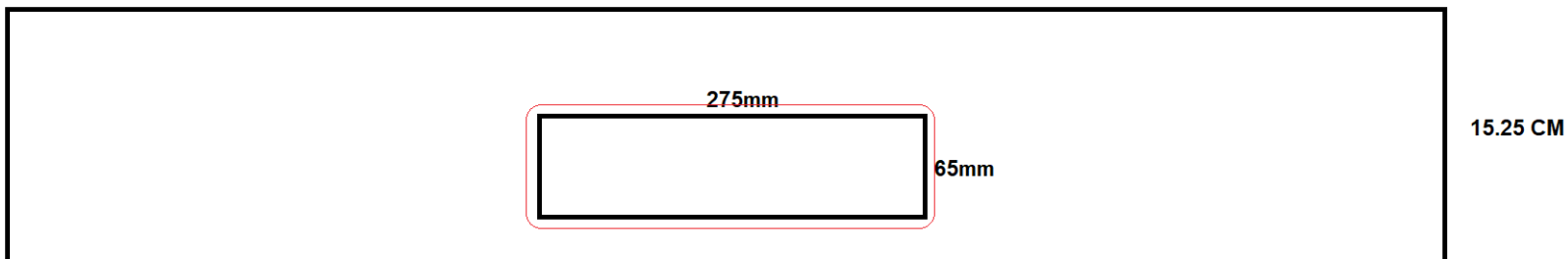

# Cabinet Position when Installing in a Drawer in Drawer Option, Or Bottom Of Existing Drawer

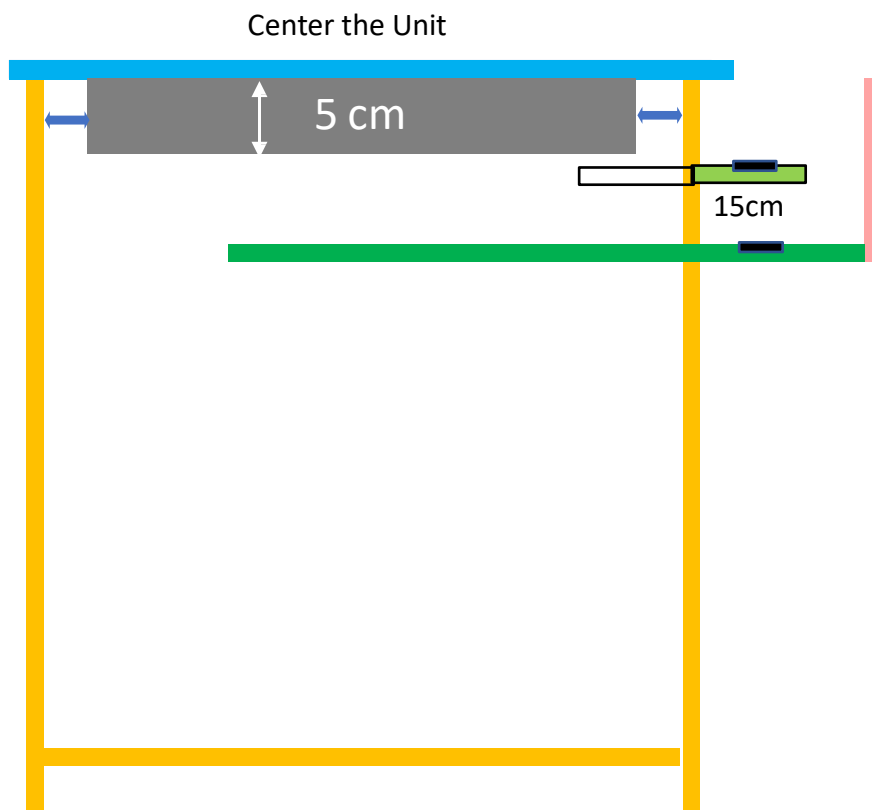
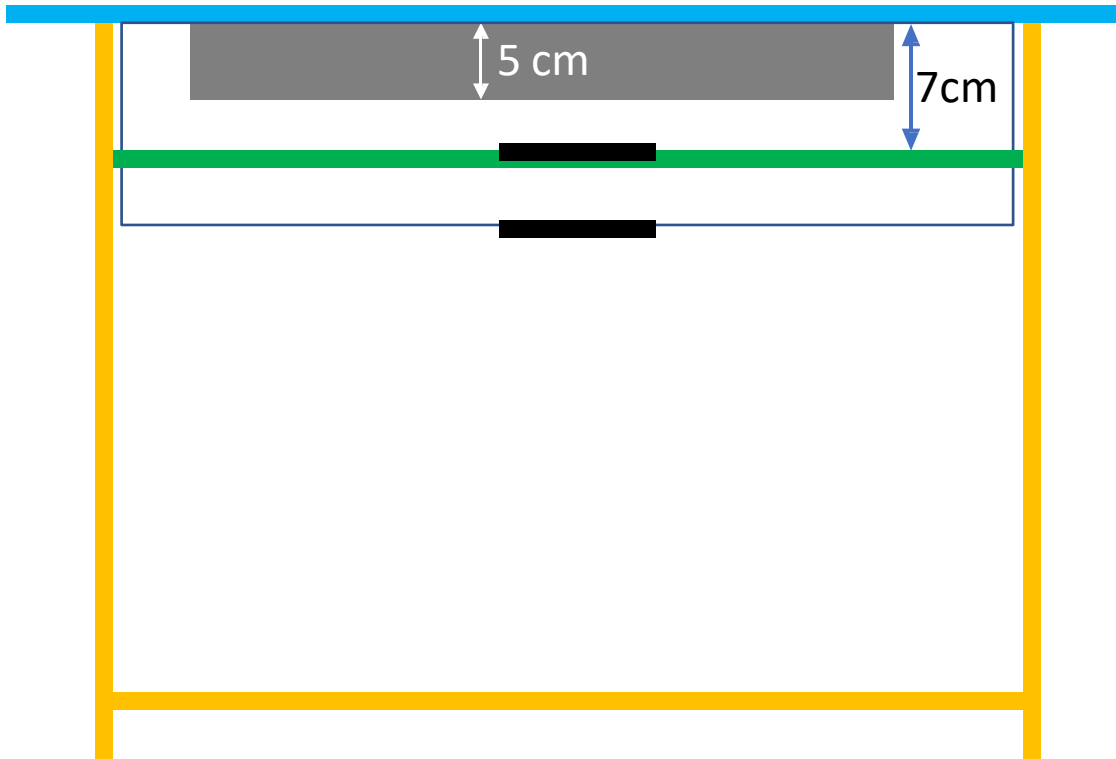



**Countertop**  
**Installation of the**  
**Controller Unit**

---

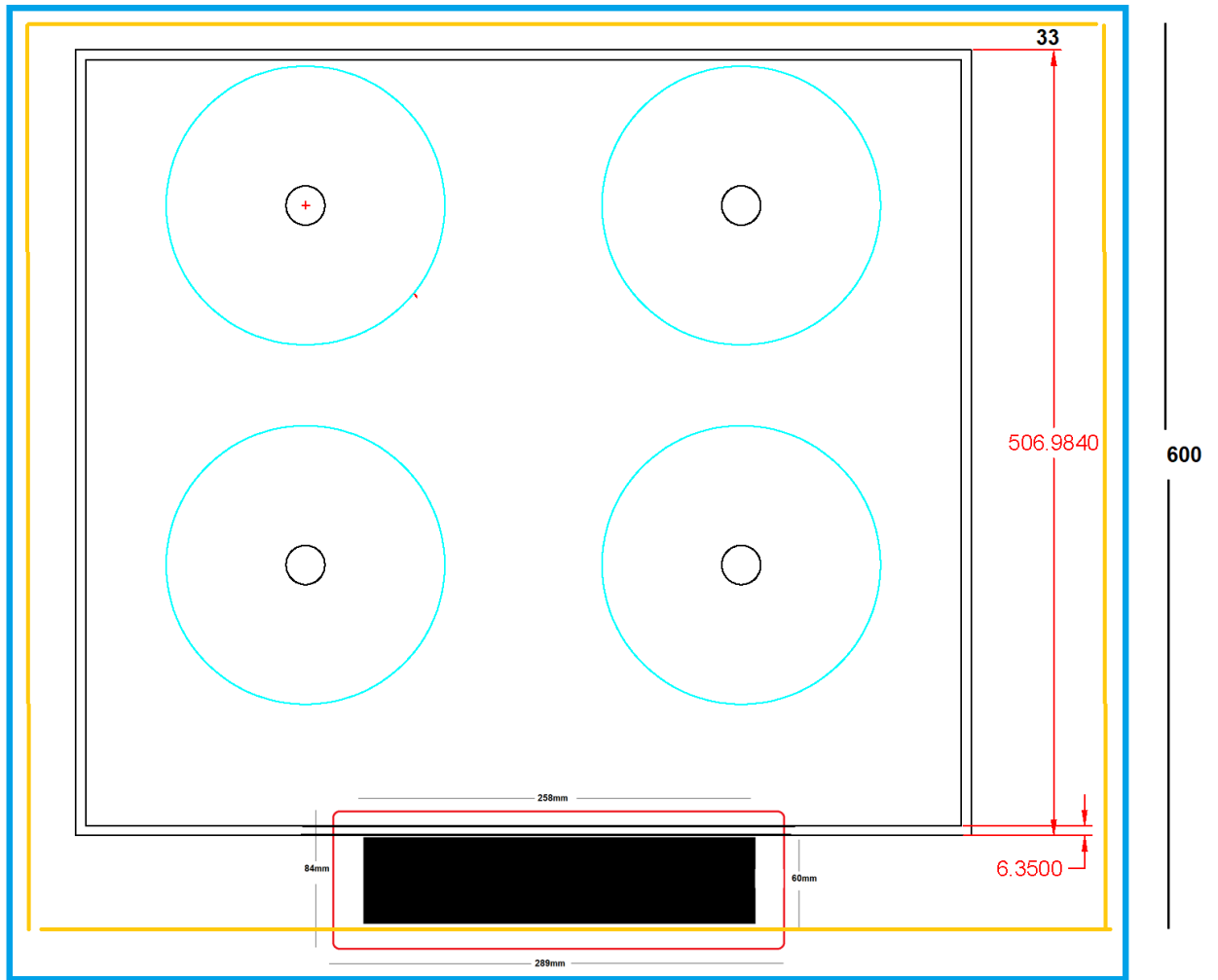

- Cabinet Outline
- Countertop Outline

Measurements in MM

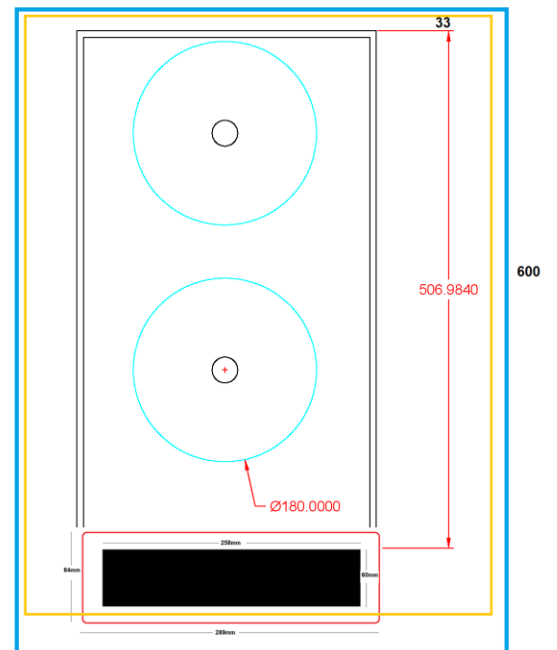
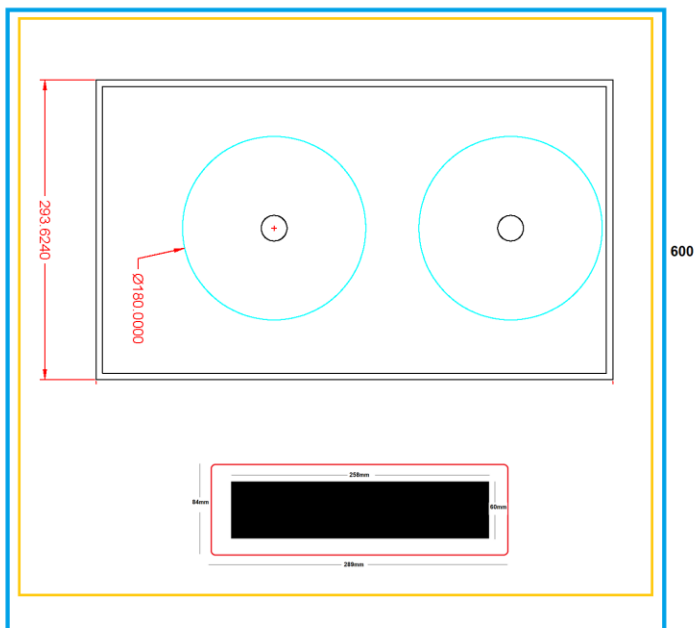

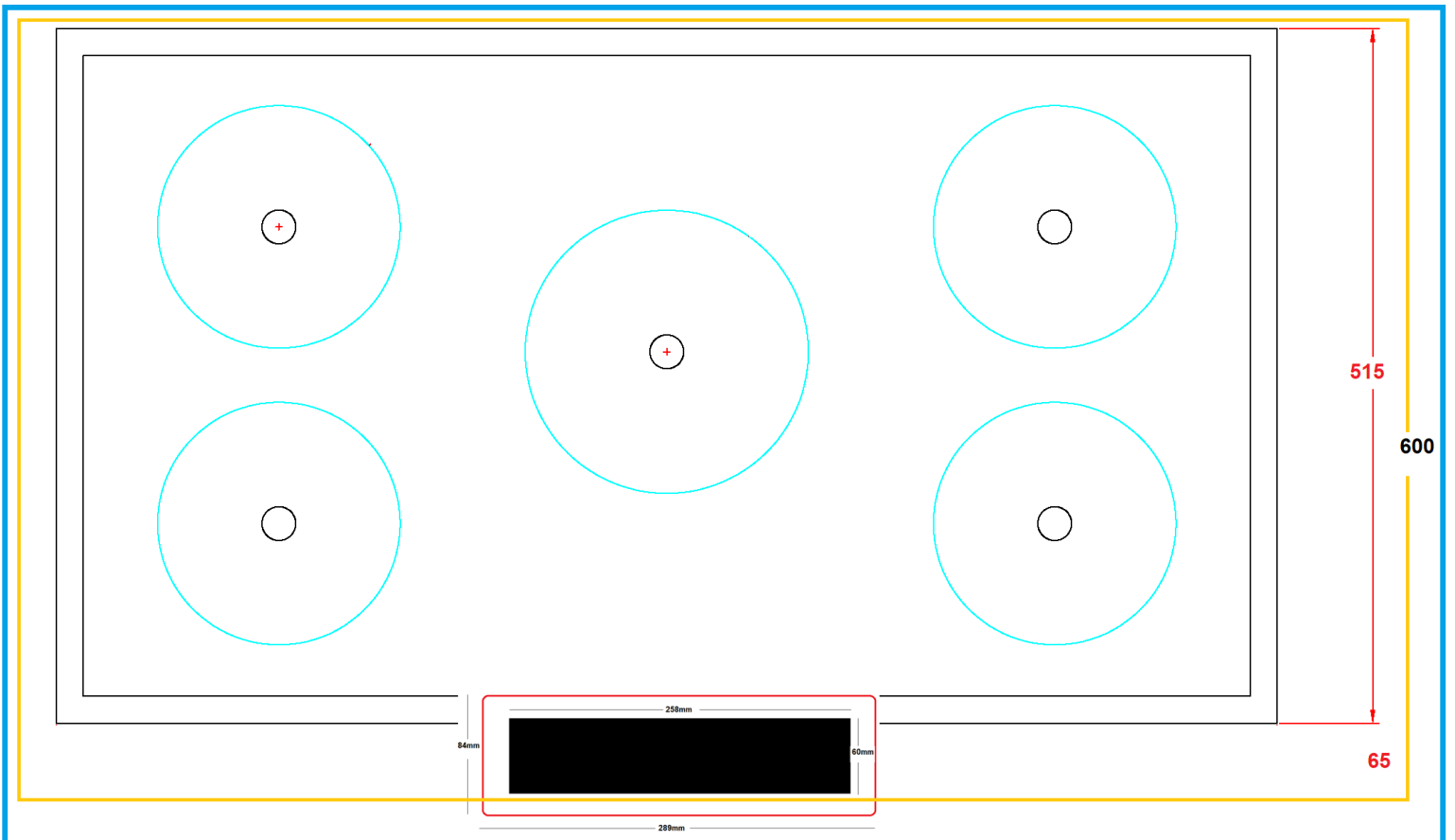
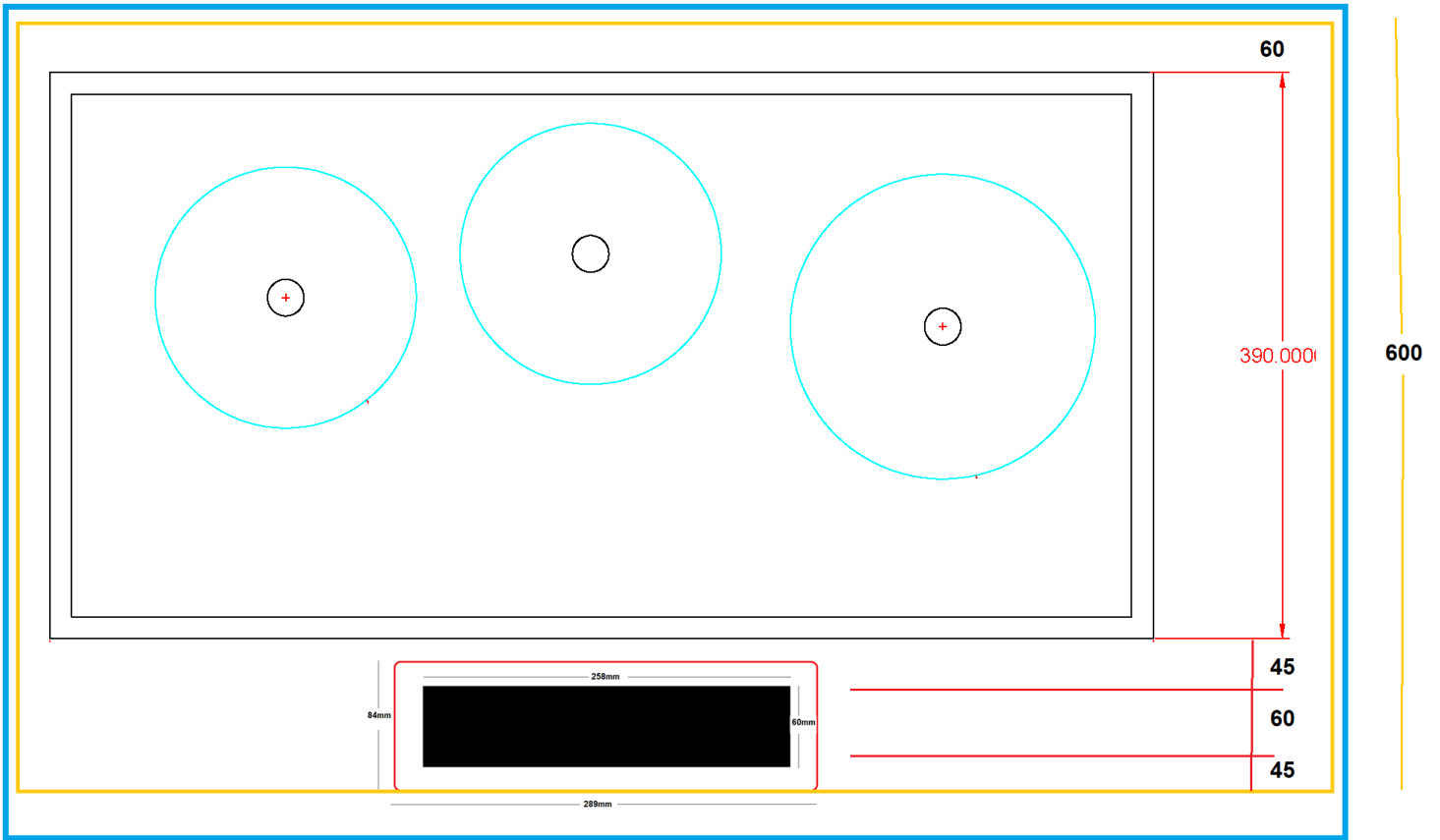

**Cabinet Position when Installing on Countertop**

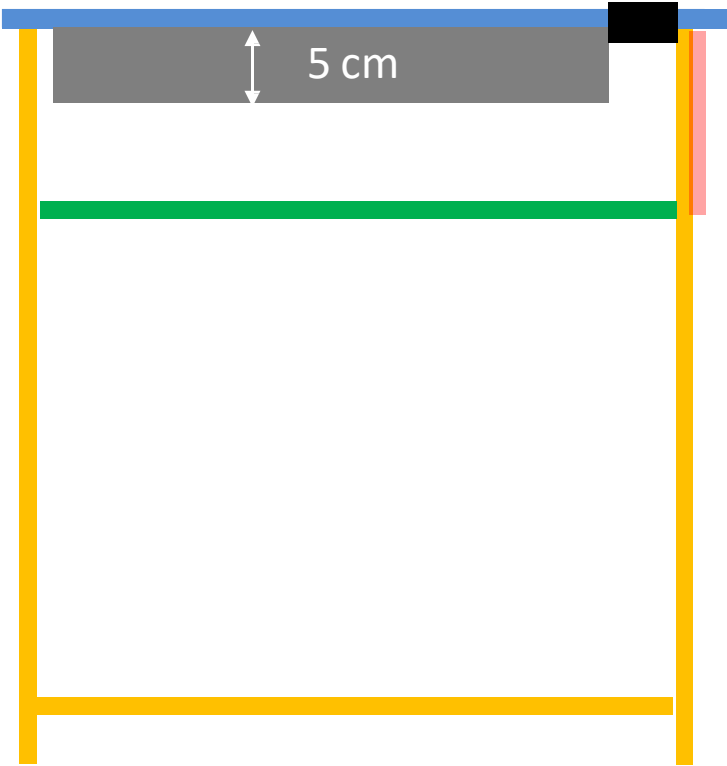
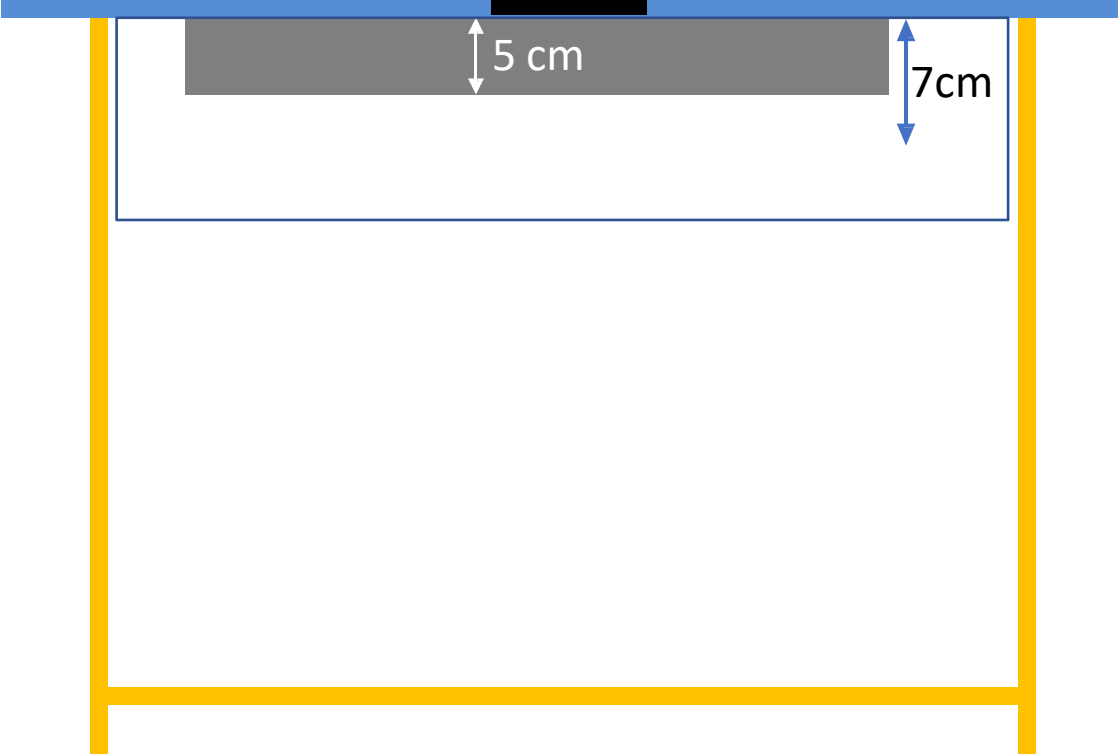



# Cabinet Face Front Controller Installation

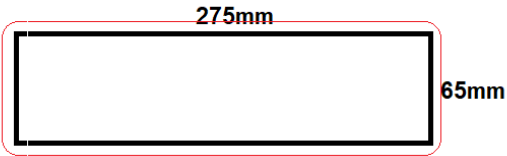
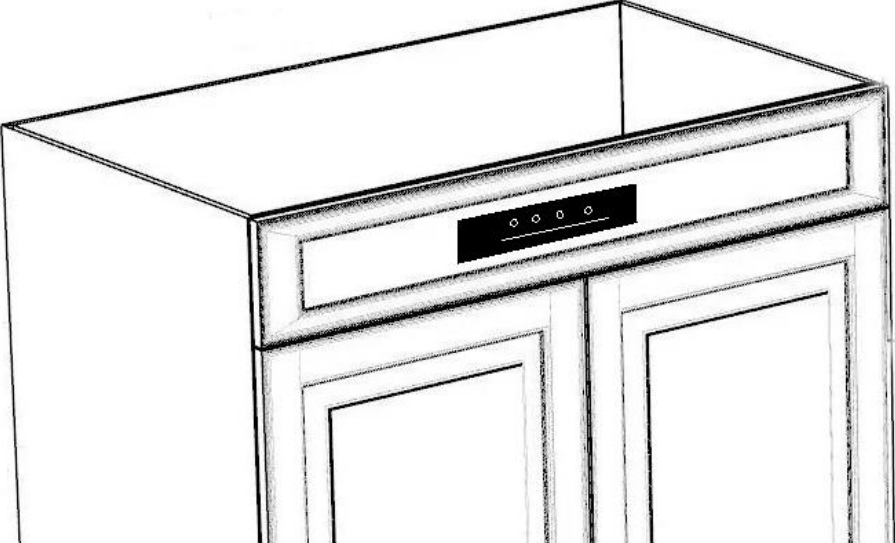



# Cabinet Position when Installing a Wall Oven Under the InvisaCook Unit.

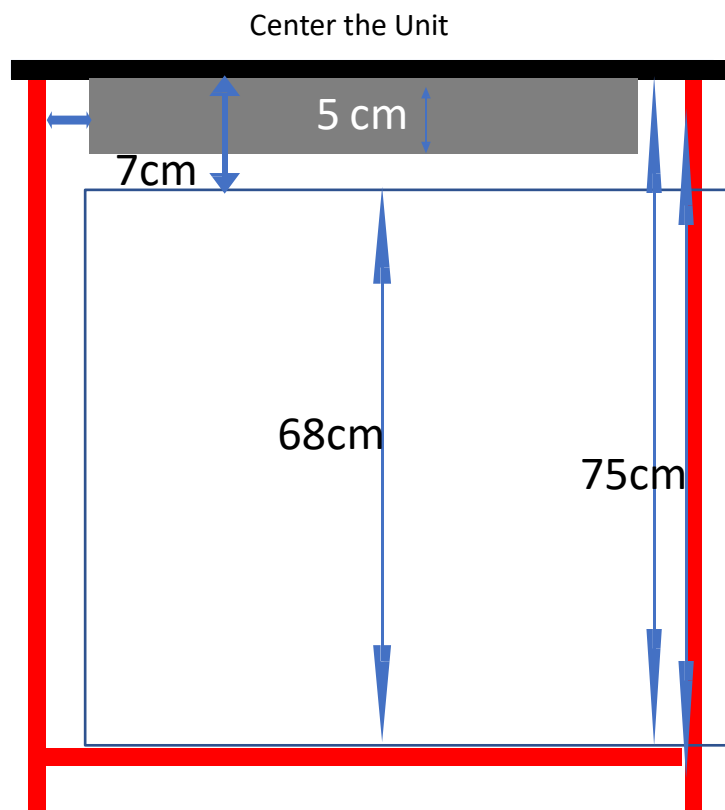
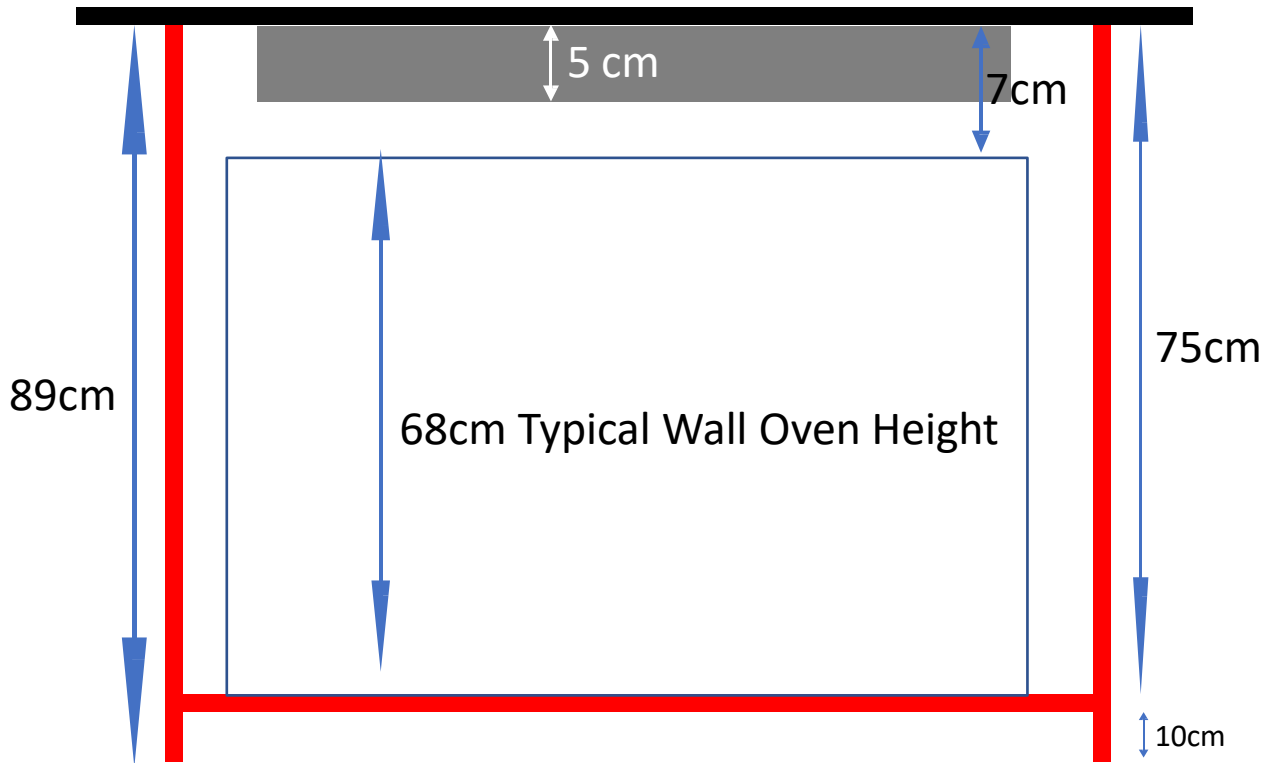

# Controller Spec Drawing

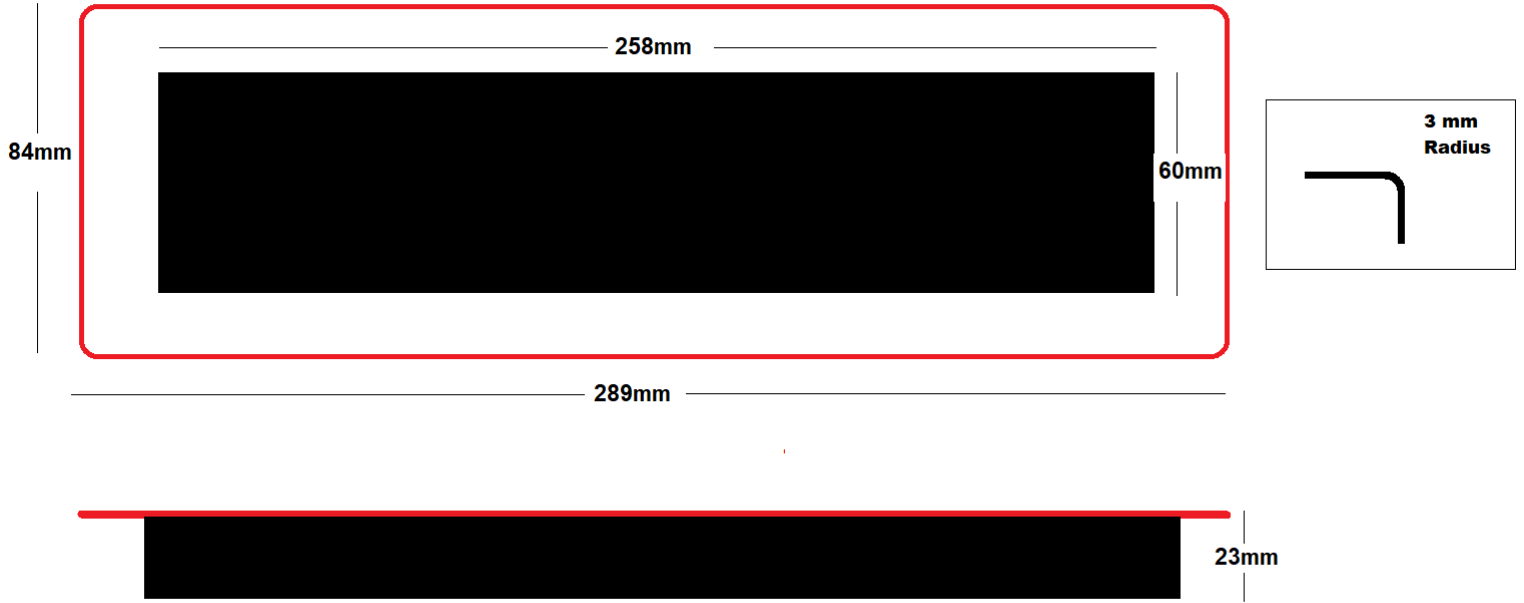

# CONTROLLER FUNCTIONALITY

5 Burner

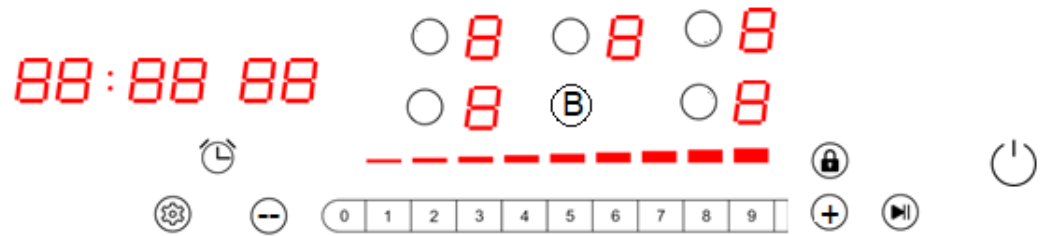

4 Burner

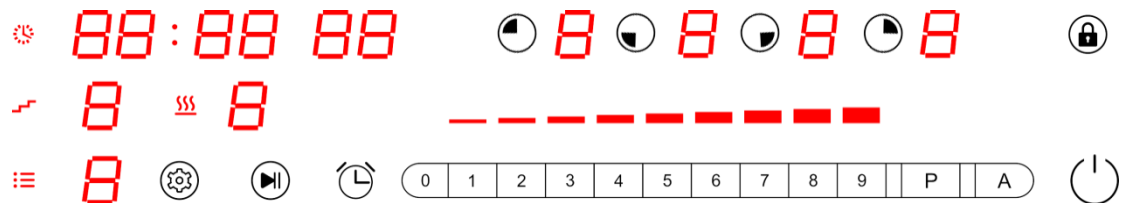

3 Burner

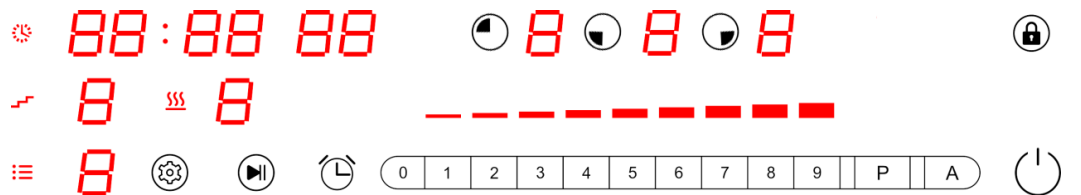

2 Burner

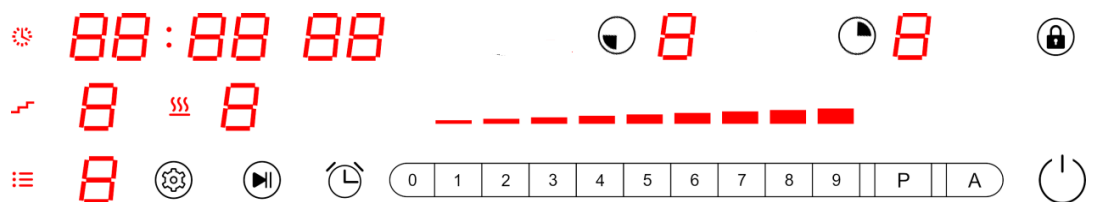

1 Burner

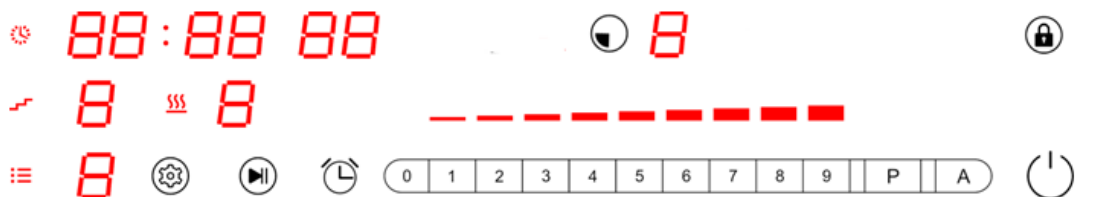

## Basic Functions

### Power on:

When power on, all the LED light 1s with beep, then go off, if working surface temperature over 60°C on this model, the related digital LED will show "H";and all the buttons are invalid except Power and Child Lock key.

### ON/OFF:

Press power key to start stand by model, indicator lights, beep once, the related digital LED will show flashing "H" if it's working surface temperature over 60°C, if not, the digital LED will show "-".timer LED will show "--".

it will return to power on model if have not any operation within 2 min.press power key can also directly return to power on model.

### Manual Mode(Power Selecting):

Press any burner key you want, now the zone is selected. When the zone is selected the power display will show "0" and start to blink. You can slide or press 0-9 to start working.

### Lock:

To avoid any mis-operation and ensure safety of children. Press this button for 3s to enable the function, the indicator will light. All buttons are invalid except Child Lock and power key.

### Booster:

Activate Booster = Select first the cooking zone and then pressBooster, now the Booster will be activated, and the power display will show [ P ].

Deactivate Booster = Select first the cooking zone and then press booster, now the Booster will be deactivated, and the power display will return to previous power level.

### Timer:

You can set the time max to 99minutes and this button can be activated only when burner is working . Press 09 keys to set timer.

### Smart Functions:



#### Recording:



When Burner is working on Manual model (see above), long press the setting key , the device will record your cooking process(power level and cooking time).









Each time when you adjust the power level, the device will start a new step to record power level and cooking time, 4 steps at most.

Press  to finish recording or when the 4 steps recorded, it will finish recording automatically.

## DIY Menu(programming)

On standby mode, long press setting key  to amend/build the current menus, now the menu number  LED will blink.

Press 1-9 to select the menu you want to amend/build, short press  /  to enter the menu, now the cooking step  LED will blink.

Repeat short press  /  can change to power level  and  cooking time(M:S) setting, this can change in a cycle: from  to  to  to  ...



Cooking step: all in 4 steps, power level: can be 1-9,cooking time: max to 99s:99s.

When you finish setting, long press  to save.

## Auto Mode:

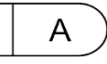
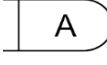

### Auto cooking:

On standby mode, select one burner, press  to enter auto cooking mode, now the burner LED will show "A" now the menu number will blink (press  again can return to last step).

Press 1-9 to select menu, press  to start working, the food will be ready automatically (press  can stop cooking and select menu again).

There will be a point at lower right corner to remind the menu belongs to current burner.

Pre-set for menu:

On auto cooking mode, when you select menu number, press  to pre-set, now the  LED will blink.

Press 0-9 to set time, max can be 99h:99m.

Press  to start pre-set, when time is up, the device will cook automatically.

# Units Power and Consumption

## 5 Burner Unit 220V

Top Left : Nominal Power: 1000W(LEVEL 9) /1200W(Boost)

Bottom Left: Nominal Power: 1000W(LEVEL 9) /1200W(Boost)

Middle: Nominal Power: 1300W(LEVEL 9) /1500W(Boost)

Top Right : Nominal Power: 1000W(LEVEL 9) /1200W(Boost)

Bottom Right: Nominal Power: 1000W(LEVEL 9) /1200W(Boost)

Max power for four is 5,600w

5 Burner Unit										
Levels	L-Top B	L-Lower B	Levels	Levels	Large M	Levels	R-Top B	R-Lower B	Levels	
P	1200W	0-W	0	P	1500W	P	1200W	0-W	0	
9	1000W	600W	1	9	1300W	9	1000W	600W	1	
8	950W	650W	2	8	1200W	8	950W	650W	2	
7	900W	700W	3	7	1100W	7	900W	700W	3	
6	850W	750W	4	6	1000W	6	850W	750W	4	
5	800W	800W	5	5	900W	5	800W	800W	5	
4	750W	850W	6	4	800W	4	750W	850W	6	
3	700W	900W	7	3	700W	3	700W	900W	7	
2	650W	950W	8	2	600W	2	650W	950W	8	
1	600W	1000W	9	1	500W	1	600W	1000W	9	
0	0-W	1200W	P	0	0-W	0	0-W	1200W	P	

## 4 Burner Unit 220V

Top Left : Nominal Power: 1000W(LEVEL 9) /1200W(Boost)

Bottom Left: Nominal Power: 1000W(LEVEL 9) /1200W(Boost)

Middle: Nominal Power: 1300W(LEVEL 9) /1500W(Boost)

Top Right : Nominal Power: 1000W(LEVEL 9) /1200W(Boost)

Bottom Right: Nominal Power: 1000W(LEVEL 9) /1200W(Boost)

Max power for four is 4,000w

4 Burner Unit								
Levels	L-Top B	L-Lower B	Levels	Levels	R-Top B	R-Lower B	Levels	
P	1200W	0-W	0	P	1200W	0-W	0	
9	1000W	600W	1	9	1000W	600W	1	
8	950W	650W	2	8	950W	650W	2	
7	900W	700W	3	7	900W	700W	3	
6	850W	750W	4	6	850W	750W	4	
5	800W	800W	5	5	800W	800W	5	
4	750W	850W	6	4	750W	850W	6	
3	700W	900W	7	3	700W	900W	7	
2	650W	950W	8	2	650W	950W	8	
1	600W	1000W	9	1	600W	1000W	9	
0	0-W	1200W	P	0	0-W	1200W	P	

### **3 Burner Unit 220V**

Left : Nominal Power: 1000W(LEVEL 9) /1200W(Boost)

Middle Left: Nominal Power: 1000W(LEVEL 9) /1200W(Boost)

Large Right: Nominal Power: 1300W(LEVEL 9) /1500W(Boost)

Max power for four is 3,600w

3 Burner Unit					
Levels	Left Corner	Middle	Levels	Levels	Larger R
P	1200W	0-W	0		P 1500W
9	1000W	600W	1		9 1300W
8	950W	650W	2		8 1200W
7	900W	700W	3		7 1100W
6	850W	750W	4		6 1000W
5	800W	800W	5		5 900W
4	750W	850W	6		4 800W
3	700W	900W	7		3 700W
2	650W	950W	8		2 600W
1	600W	1000W	9		1 500W
0	0-W	1200W	P		0 0-W

### **2 Burner Unit 220V**

Top : Nominal Power: 1000W(LEVEL 9) /1200W(Boost)

Bottom: Nominal Power: 1000W(LEVEL 9) /1200W(Boost)

Max power for four is 2,000w

2 Burner 220V			
Levels	Top B	Lower B	Levels
P	1200W	0-W	0
9	1000W	600W	1
8	950W	650W	2
7	900W	700W	3
6	850W	750W	4
5	800W	800W	5
4	750W	850W	6
3	700W	900W	7
2	650W	950W	8
1	600W	1000W	9
0	0-W	1200W	P

***1 & 2 Burner Unit 110V are on North American Standard Plug and outlet.***